

INSTALLATION MANUAL



PSD-BW/PSD-BWL Nesting Cart Series

NORTH AMERICA

3130 East Miraloma Avenue
Anaheim, CA 92806 USA
USA and Canada –
Phone: 800-368-9700
Fax: 800-832-4888

EUROPE

Swallow House,
Shilton Industrial Estate,
Shilton, Coventry, England CV79JY
Phone: +44 (0) 2476 614700
Fax: +44 (0) 2476 614710

AUSTRALIA, NEW ZEALAND, OCEANIA (Distributor)

P.O. Box 295
Mordialloc Victoria 3195
Australia
Phone: 03 9586 6330
www.premiermounts.com.au

Other Locations – Phone: 001.714.632.7100; Fax: 001.714.632.1044

©Premier Mounts 2007



Table of Contents

WARRANTY - 2 -

CONTACT PREMIER MOUNTS - 2 -

WARNING STATEMENTS - 3 -

PARTS LIST - 4 -

INSTALLATION TOOLS - 4 -

BW BASE CASTOR INSTALLATION (FIGURE 1) - 5 -

SUPPORT TUBE INSTALLATION (FIGURE 2) - 5 -

PSD-SPA INSTALLATION (FIGURE 3) - 6 -

PSD-BW/L NESTING CART STORAGE (FIGURE 4) - 6 -

OPTIONAL MOUNTING CONFIGURATIONS - 7 -

TECHNICAL SPECIFICATIONS - 8 -

NOTES - 8 -

Warranty

Limited Lifetime Warranty

All Premier Mounts products carry a limited lifetime warranty from ship date against defects in materials and workmanship. Premier Mounts is not liable for improper installation that results in damage to mounts, adapters, display equipment or personal injury.

Contact Premier Mounts

In the event of missing and/or damage equipment, or technical questions, the following information can help in the completion of the installation.

Customer Service – (800) 368-9700

Technical Support – techsupport@mounts.com



Warning Statements

WARNING: PREMIER MOUNTS DOES NOT WARRANT AGAINST DAMAGE CAUSED BY THE USE OF ANY PREMIER MOUNTS PRODUCT FOR PURPOSES OTHER THAN THOSE FOR WHICH IT WAS DESIGNED OR DAMAGE CAUSED BY UNAUTHORIZED ATTACHMENTS OR MODIFICATIONS, AND IS NOT RESPONSIBLE FOR ANY DAMAGES, CLAIMS, DEMANDS, SUITS, ACTIONS OR CAUSES OF ACTION OF WHATEVER KIND RESULTING FROM, ARISING OUT OF OR IN ANY MANNER RELATING TO ANY SUCH USE, ATTACHMENTS OR MODIFICATIONS.

WARNING: THE FLOOR STRUCTURE MUST BE CAPABLE OF SUPPORTING AT LEAST 250 LBS. IF NOT, THE FLOOR STRUCTURE MUST BE REINFORCED. PROPER INSTALLATION PROCEDURE BY A QUALIFIED SERVICE TECHNICIAN, AS OUTLINED IN THE INSTALLATION INSTRUCTIONS, MUST BE ADHERED TO. FAILURE TO DO SO COULD RESULT IN SERIOUS PERSONAL INJURY, OR EVEN DEATH.

WARNING: SAFETY MEASURES MUST BE PRACTICED AT ALL TIMES DURING THE ASSEMBLY OF THIS PRODUCT. USE PROPER SAFETY GEAR AND TOOLS FOR THE ASSEMBLY PROCEDURE TO PREVENT PERSONAL INJURY.

WARNING: PRIOR TO THE INSTALLATION OF THIS PRODUCT, THE ASSEMBLY INSTRUCTIONS SHOULD BE READ AND COMPLETELY UNDERSTOOD. THE ASSEMBLY INSTRUCTIONS MUST BE READ TO PREVENT PERSONAL INJURY AND PROPERTY DAMAGE. KEEP THESE ASSEMBLY INSTRUCTIONS IN AN EASILY ACCESSIBLE LOCATION FOR FUTURE REFERENCE.



Indicates that the power plug is to be disconnected from the power outlet.



Contact Premier Mounts with any questions.



Safety precautions must be taken at all times.



Warning and Caution statements.



Do not install on a structure that is prone to vibration, movement or chance of impact. Failure to do so could result in damage to the plasma display and/or damage to the mounting surface.



Do not install near heater, fireplace, direct sunlight, air conditioning or any other source of direct heat energy. Failure to do so may result in damage to the display and could increase the risk of fire.



At least two qualified people should perform the assembly procedure. Injury and/or damage can result from dropping or mishandling the display.

DANGER: DO NOT ATTACH EQUIPMENT WEIGHING MORE THAN 75LBS. ABOVE THE 60” MARKED LINE ON THE SUPPORT POLES. DOING SO MAY CAUSE THE NESTING CART TO TIP OVER, RESULTING IN SEVERE PROPERTY DAMAGE AND/OR PERSONAL INJURY.



Parts List

Congratulations on purchasing the PSD-BW/PSD-BWL Nesting Cart. The PSD-BW/PSD-BWL Nesting Cart is shipped with all proper installation hardware and components. Please verify that none of these parts are missing and/or damaged before assembly. If there are parts missing and/or damaged, please stop the assembly and contact Premier Mounts (800) 368-7000.

NOTE: Some mounting configurations will allow for a “landscape” orientation. In these situations, when moving the PSD-BW/L Nesting Cart through a doorway, the orientation of the display must be returned to the “portrait” orientation. If not, maneuvering through the doorway could prove costly by damaging the display.

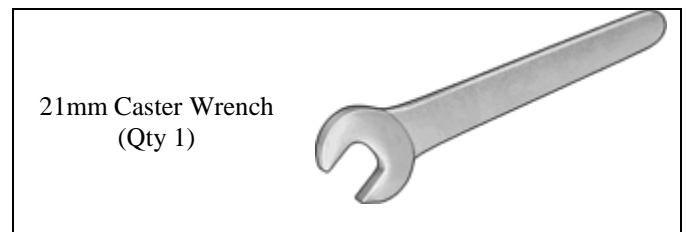
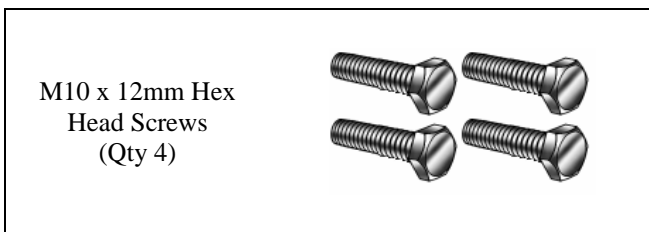
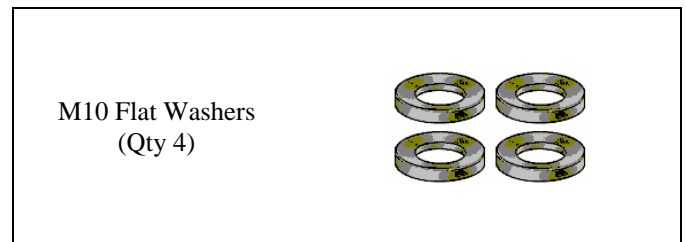
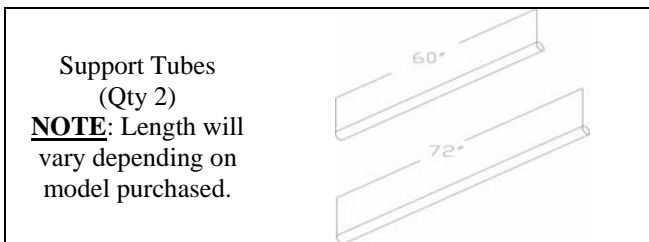
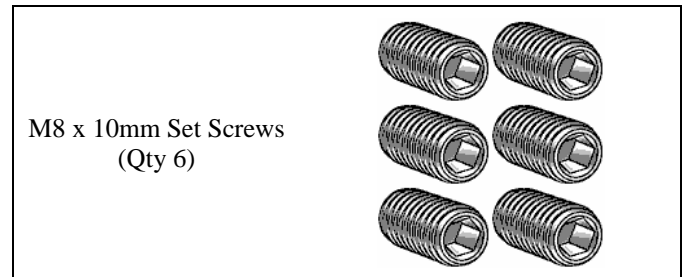
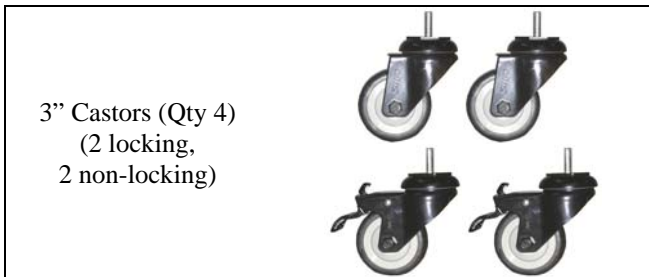
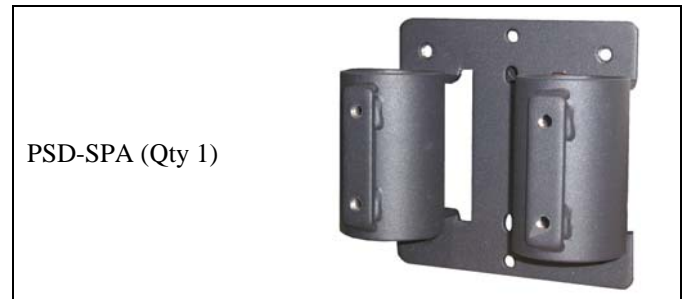

Installation Tools

Socket head wrench
M5 Allen Wrench (Supplied)

Soft Material/ Blanket
5/32” Allen Wrench (Supplied)



BW Base Castor Installation (Figure 1)

Unpack the PSD-BW/L Nesting Cart and review any WARNING statements that apply to the installation. Select the desired location for the PSD-BW/L Nesting Cart.

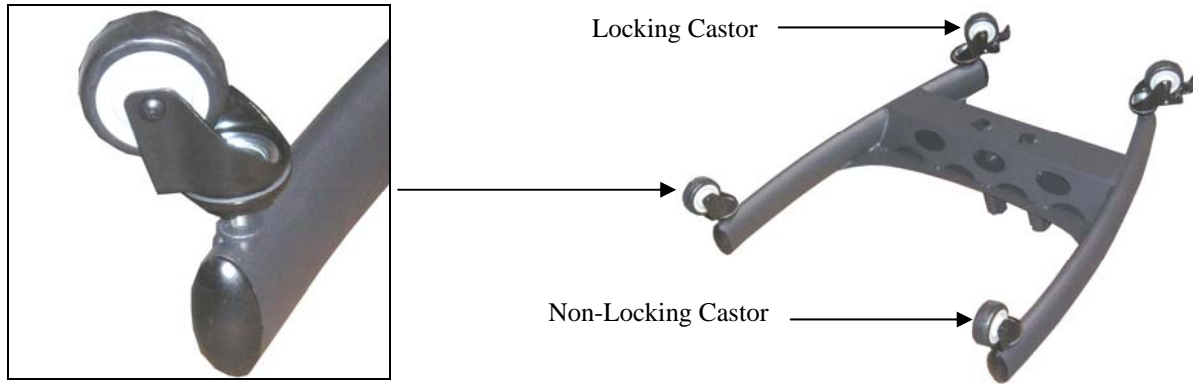

Figure 1

1. Place the BW/L on a flat surface.

NOTE: Make sure the locking castors (Qty 2) are attached to the rear legs of the Nesting Cart.

2. Insert each castor into the threaded mounting point located on the underside of the BW/L base (Figure 1). Turn each castor clockwise to tighten. Make sure all four castors are tightened all the way until flush with the base. Tighten using the 21mm castor wrench (supplied).

Support Tube Installation (Figure 2)

1. Place the BW/L on a flat surface.
2. Take the support tubes and slide them over the mounting clamps that are located on the Nesting Cart.

NOTE: To perform the following step, the access holes that are located at the end of the support tubes must line up with the set screw holes on the mounting clamps. The upper access holes will be used for cable management once the display has been mounted to the support tubes.

3. Insert the set screws into each hole and tighten using the supplied M5 Allen Wrench (Figure 2).

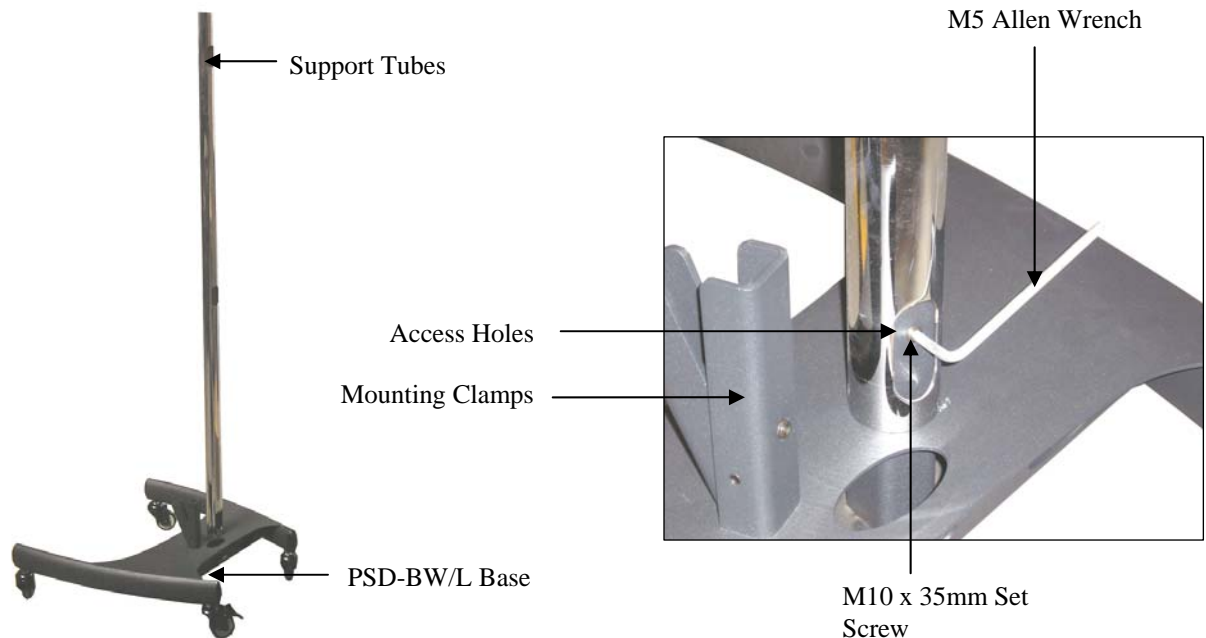

Figure 2



PSD-SPA Installation (Figure 3)

NOTE: Use of the PSD-SPA will depend on the mount that is used. All PSM/CTM Series mounts require using the PSD-SPA. The Revolution Series, USA and UFA Mounts, however, do not require the use of the PSD-SPA.

1. Slide the PSD-SPA over and down the support tubes.
2. Once the desired height has been determined, tighten the four (4) M8 x 10mm set screws, using the 5/32" Allen wrench (supplied) to secure the PSD-SPA (Figure 3).



Figure 3

PSD-BW/L Nesting Cart Storage (Figure 4)

The PSD-BW/L is designed to maximize storage space. When storing multiple carts, slide the Nesting Carts together as close as possible.

NOTE: Please adhere to any WARNING statements that will apply to the different mounting configurations the PSD-BW/L Nesting Cart will be used with.

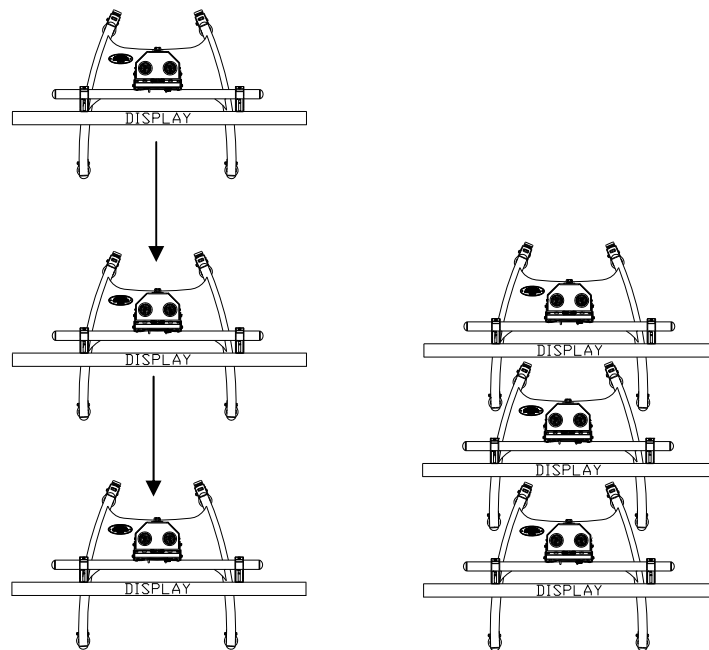
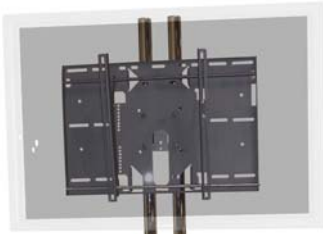

Figure 4



Optional Mounting Configurations



CTM-Series

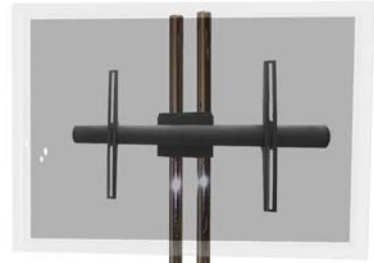

Revolution Series



USA/UFA Series



Technical Specifications

All measurements are in inches (mm).

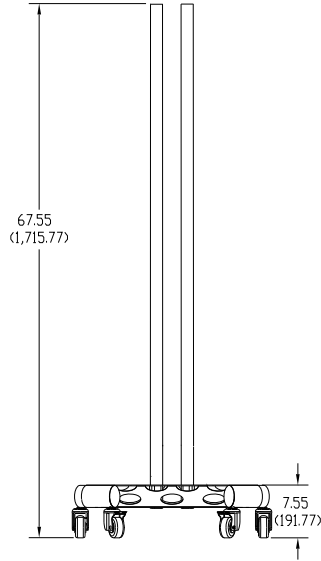

PSD-BW

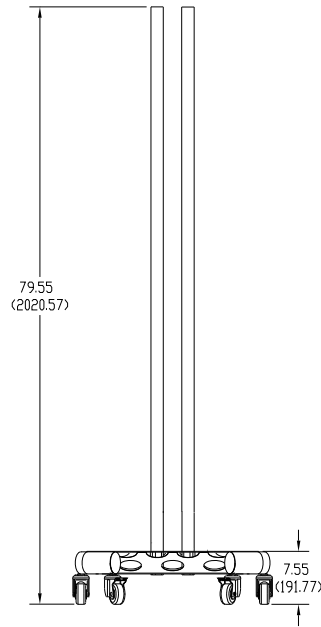

PSD-BWL

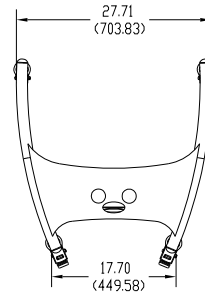
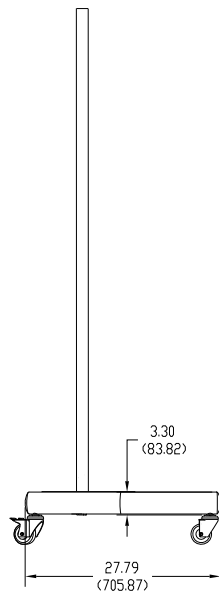

Notes

Installation Instructions

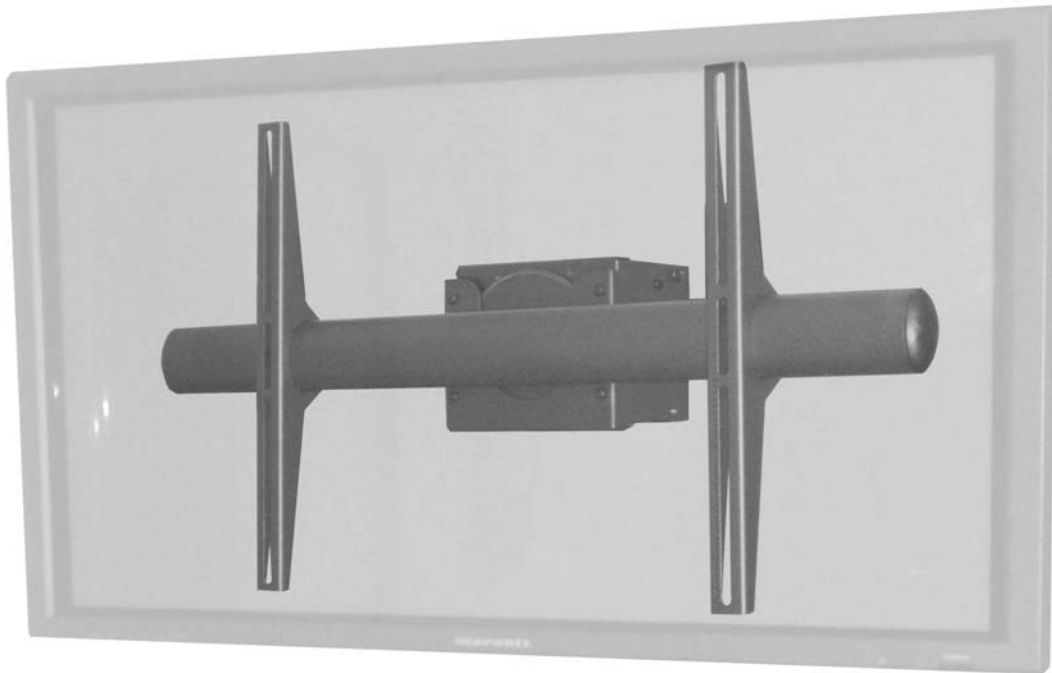

Rotary Series

Rotary Tilt Mount Model: RTM-L

NORTH AMERICA

3130 East Miraloma Avenue
Anaheim, CA 92806 USA
USA and Canada -
Phone: 800-368-9700
Fax: 800-832-4888

EUROPE

Swallow House,
Shilton Industrial Estate,
Shilton, Coventry, England CV79JY
Phone: +44 (0) 2476 614700
Fax: +44 (0) 2476 614710

AUSTRALIA, NEW ZEALAND, OCEANIA (Distributor)

P.O. Box 295
Mordialloc Victoria 3195
Australia
Phone: 03 9586 6330
www.premiermounts.com.au



TABLE OF CONTENTS

Warranty	2
Contact Premier Mounts	2
Warning Statements	3
Parts List	4
Installation Tools.....	4
Thread Depth Indicator	7
Mount Installation	8
Universal Mounting Bracket Installation	9
Display Orientation	11
Securing the Display	11
Tilt Positioning	12
Optional Configurations	12
Technical Specifications	12
Addendum	13

PREMIER MOUNTS LIMITED LIFETIME WARRANTY

What and Who is Covered by this Limited Warranty and for How Long

Premier Mounts warrants this product to be free from defects in material and workmanship for the lifetime of the original owner of this product. The limited warranty is valid only for the original purchaser of the product.

What Premier Mounts Will Do

At the sole option of Premier Mounts, Premier Mounts will repair or replace any product or product part that is defective. If Premier Mounts chooses to replace a defective product or part, a replacement product or part will be shipped to you at no charge, but you must pay any labor costs.

What is Not Covered; Limitations

PREMIER MOUNTS DISCLAIMS ANY LIABILITY FOR DAMAGE TO MOUNTS, ADAPTERS, DISPLAYS, PROJECTORS, OTHER PROPERTY, OR PERSONAL INJURY RESULTING, IN WHOLE OR IN PART, FROM IMPROPER INSTALLATION, MODIFICATION, USE OR MISUSE OF ITS PRODUCTS.

PREMIER MOUNTS DISCLAIMS ALL OTHER WARRANTIES, EXPRESS OR IMPLIED, INCLUDING WARRANTIES OF MERCHANTABILITY AND FITNESS FOR A PARTICULAR PURPOSE. PREMIER MOUNTS IS NOT RESPONSIBLE FOR INCIDENTAL OR CONSEQUENTIAL DAMAGES, INCLUDING BUT NOT LIMITED TO, INABILITY TO USE ITS PRODUCTS OR LABOR COSTS FOR REMOVING AND REPLACING DEFECTIVE PRODUCTS OR PARTS. SOME STATES DO NOT ALLOW THE EXCLUSION OR LIMITATION OF INCIDENTAL OR CONSEQUENTIAL DAMAGES, SO THE ABOVE LIMITATION OR EXCLUSION MAY NOT APPLY TO YOU.

What Customers Must Do for Limited Warranty Service

If you discover a problem that you think may be covered by the warranty you MUST REPORT it in writing to the address below within thirty (30) days. Proof of purchase (an original sales receipt) from the original consumer purchaser must accompany all warranty claims. Warranty claims must also include a description of the problem, the purchaser's name, address, and telephone number. General inquiries can be addressed to Premier Mounts Customer Service at 1-800-368-9700. Warranty claims will not be accepted over the phone or by fax.

Premier Mounts
Attn: Warranty Claim
3130 E. Miraloma Avenue
Anaheim, CA 92806

How State Law Applies

THIS WARRANTY GIVES YOU SPECIFIC LEGAL RIGHTS, AND YOU MAY ALSO HAVE OTHER RIGHTS WHICH VARY FROM STATE TO STATE.



Warning Statements

WARNING: PREMIER MOUNTS DOES NOT WARRANT AGAINST DAMAGE CAUSED BY THE USE OF ANY PREMIER MOUNTS PRODUCT FOR PURPOSES OTHER THAN THOSE FOR WHICH IT WAS DESIGNED OR DAMAGE CAUSED BY UNAUTHORIZED ATTACHMENTS OR MODIFICATIONS, AND IS NOT RESPONSIBLE FOR ANY DAMAGES, CLAIMS, DEMANDS, SUITS, ACTIONS OR CAUSES OF ACTION OF WHATEVER KIND RESULTING FROM, ARISING OUT OF OR IN ANY MANNER RELATING TO ANY SUCH USE, ATTACHMENTS OR MODIFICATIONS.

WARNING: THE MOUNTING SURFACE MUST BE CAPABLE OF SUPPORTING 160 LBS. IF NOT, THE MOUNTING SURFACE MUST BE REINFORCED. PROPER INSTALLATION PROCEDURES BY A QUALIFIED SERVICE TECHNICIAN, AS OUTLINED IN THE INSTALLATION INSTRUCTIONS, MUST BE ADHERED TO. FAILURE TO DO SO COULD RESULT IN SERIOUS PERSONAL INJURY, OR EVEN DEATH.

WARNING: SAFETY MEASURES MUST BE PRACTICED AT ALL TIMES DURING THE INSTALLATION OF THIS PRODUCT. USE PROPER SAFETY GEAR AND TOOLS FOR THE INSTALLATION PROCEDURE TO PREVENT PERSONAL INJURY.

WARNING: PRIOR TO THE INSTALLATION OF THIS PRODUCT, THE INSTALLATION INSTRUCTIONS SHOULD BE READ AND COMPLETELY UNDERSTOOD. THE INSTALLATION INSTRUCTIONS MUST BE READ TO PREVENT PERSONAL INJURY AND PROPERTY DAMAGE. KEEP THESE INSTALLATION INSTRUCTIONS IN AN EASILY ACCESSIBLE LOCATION FOR FUTURE REFERENCE.



Indicates that the power plug is to be disconnected from the power outlet.



Safety precautions must be taken at all times.



Warning and Caution statements.



A secure structure must support the weight, or load, of the display.



Do not install on a structure that is prone to vibration, movement or chance of impact. Failure to do so could result in damage to the display and/or damage to the mounting surface.



Do not install near heater, fireplace, direct sunlight, air conditioning or any other source of direct heat energy. Failure to do so may result in damage to the display and could increase the risk of fire.



At least two qualified people should perform the installation procedure. Injury and/or damage can result from dropping or mishandling the display.



Contact Premier Mounts with any technical/ installation questions.



Parts List

NOTE: This mount is shipped with all installation hardware and components. Make sure that none of these parts are missing and/ or damaged before beginning installation. If there are parts missing and/or damaged, please stop and contact Premier Mounts (800) 368-9700.

Universal
Mounting Brackets
(Qty 2)



Griplate™ (Qty 8)

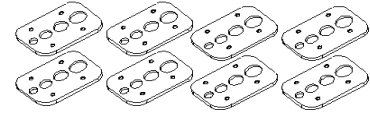

M6 Knurl Knob
(Qty 1)



Hand Crank (Qty 1)



Rotary Tilt
Mount (Qty 1)



Installation Tools

Phillips Head Screw Driver
Tape Measure
5/32" Allen Wrench (Supplied)

Soft Material/ Blanket
Thread Depth Indicator (Supplied)
Level (Supplied)

Pencil
Level (Supplied)



Parts List (Cont.)

M4 x 16  (Qty 8)

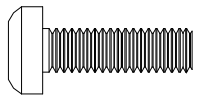
M6 x 20  (Qty 8)

M4 x 25  (Qty 8)

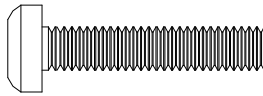
M6 x 30  (Qty 8)

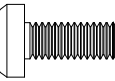
M5 x 12  (Qty 8)

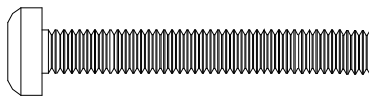
M6 x 45  (Qty 8)

M5 x 16  (Qty 8)

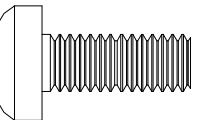
M8 x 20  (Qty 8)

M5 x 20  (Qty 8)

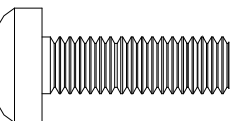
M8 x 25  (Qty 8)

M5 x 25  (Qty 8)

M5 x 50  (Qty 8)

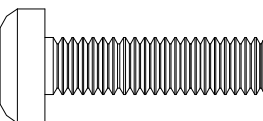
M8 x 30  (Qty 8)

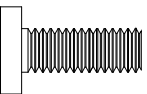
M6 x 16  (Qty 8)

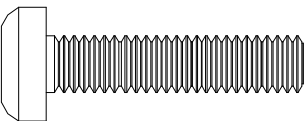
M8 x 35  (Qty 8)

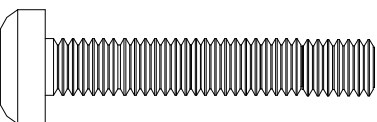
M8 x 45  (Qty 8)

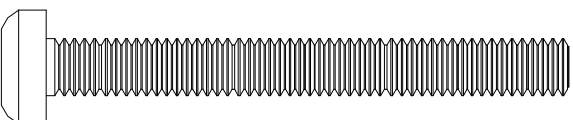
M8 x 70  (Qty 4)



Parts List (Cont.)

Nylon spacers and flat washers' actual size

NOTE: The nylon spacers may be stacked to achieve proper spacing.



1/4" Nylon spacers
(large)
(Qty 8)

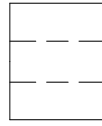

9/16" Nylon spacers
(Qty 8)

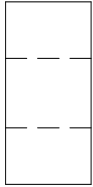

1/2" Nylon spacers
(large)
(Qty 12)

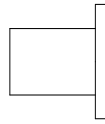

Nylon sleeves
(Qty 8)



5/16" Flat washers
(metal)
(Qty 8)

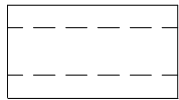

1" Nylon spacers
(Qty 8)

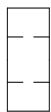

1/4" Nylon spacers
(Small)
(Qty 8)



Thread Depth Indicator

1. Insert the thread depth indicator (supplied) through the thread inserts found on the back of the flat panel to make sure the inserts measure the same full depth and mark it (Figure 1).
2. Locate the correct diameter screw for the thread insert. Compare your marking to the screws (supplied).
3. The screw length must not bypass the marking. Select another screw size (Figure 2 and 3), until you find one that comes closest to your mark without going past.
4. If your selected screw is longer than the marking on the thread depth indicator, DO NOT USE this screw.

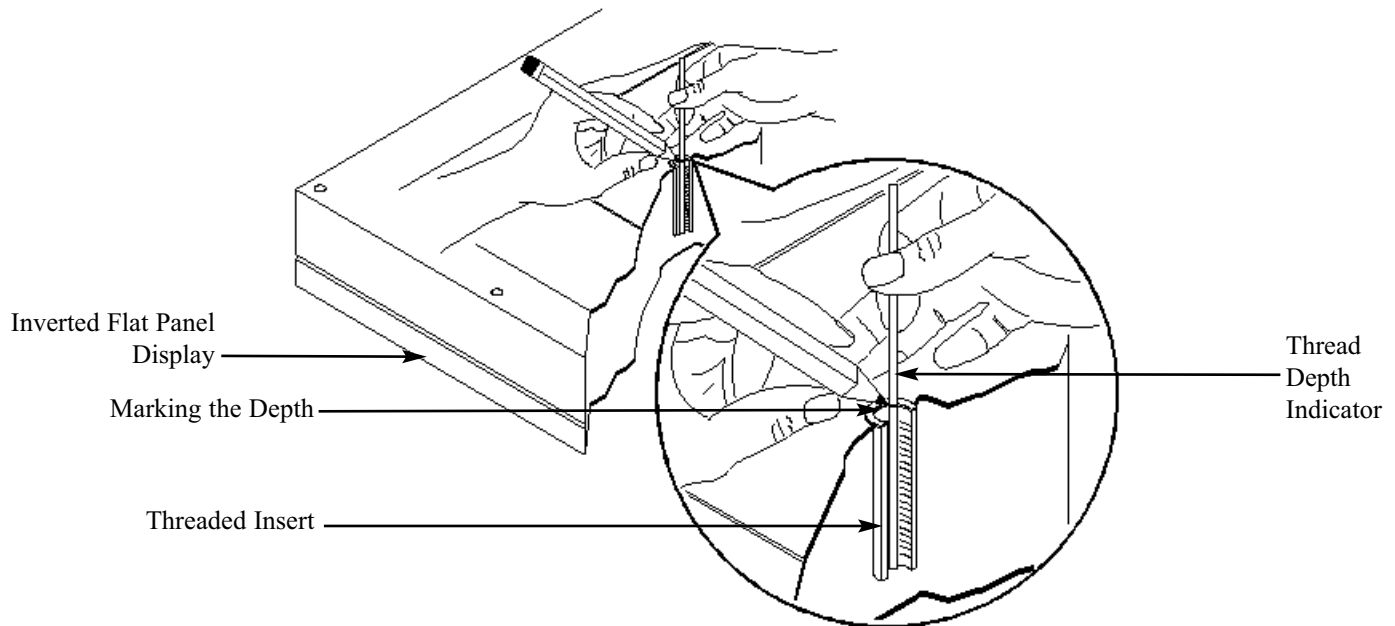

Figure 1

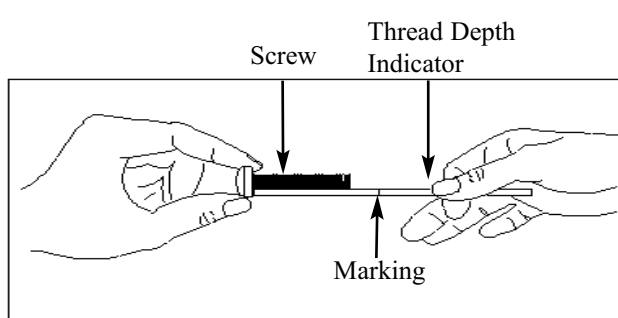

Figure 2

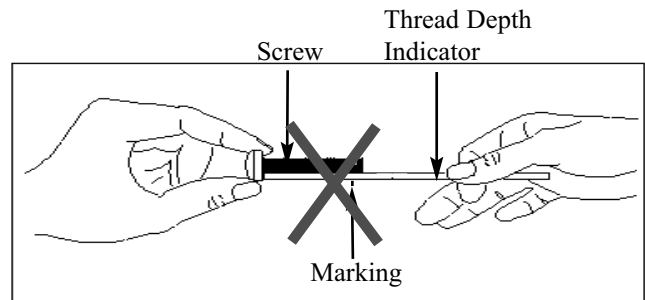

Figure 3



Mount Installation

NOTE: The installation instructions that are contained in this manual refer only to the RTM-L. The installation instructions for the various bases that are used with the RTM-L will be included with those products.

NOTE: Prior to installing the RTM-L, the mounting configuration must already be assembled (base, support poles, etc.).

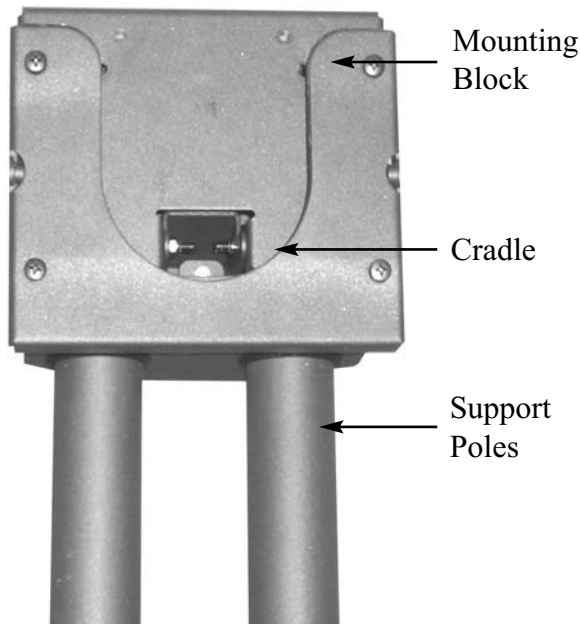

1. Slide the mounting block over and down the support poles.

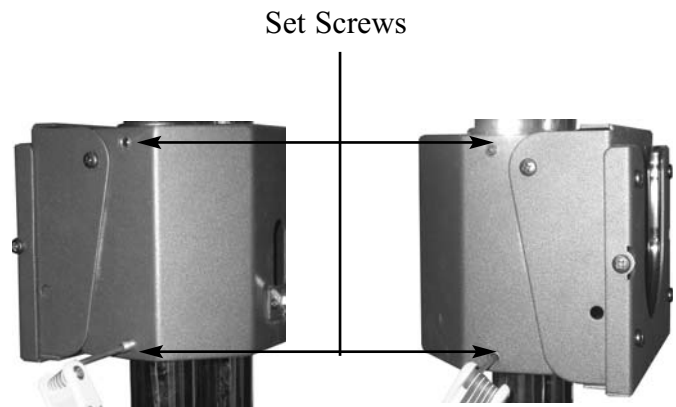

2. To secure the mounting block to the support poles, tighten the four set screws (located on each side of the mounting block), using the 5/32" Allen wrench (supplied).



Universal Mounting Bracket Assembly

1. Place the universal bracket bar and the universal brackets on a flat surface.
2. Slide the universal brackets onto the universal bracket bar (as shown below) with the set screws facing up. At this time, do not tighten the set screws that are located on the universal bracket.
3. Place the display on a soft, flat surface, face-down. Next, place the universal bracket assembly on the back of the display, with the universal brackets resting directly over the display mounting points.
4. Once the desired position has been determined, place the Griplate™ washers over each mounting point and secure them using the appropriate hardware (see Page 5).

NOTE: For the two upper mounting points, the Griplate™ dimples must be facing up. For the two lower mounting points, the Griplate™ dimples must be facing down.

5. At this time, center the universal bracket bar and tighten the set screws that are located on the universal brackets.

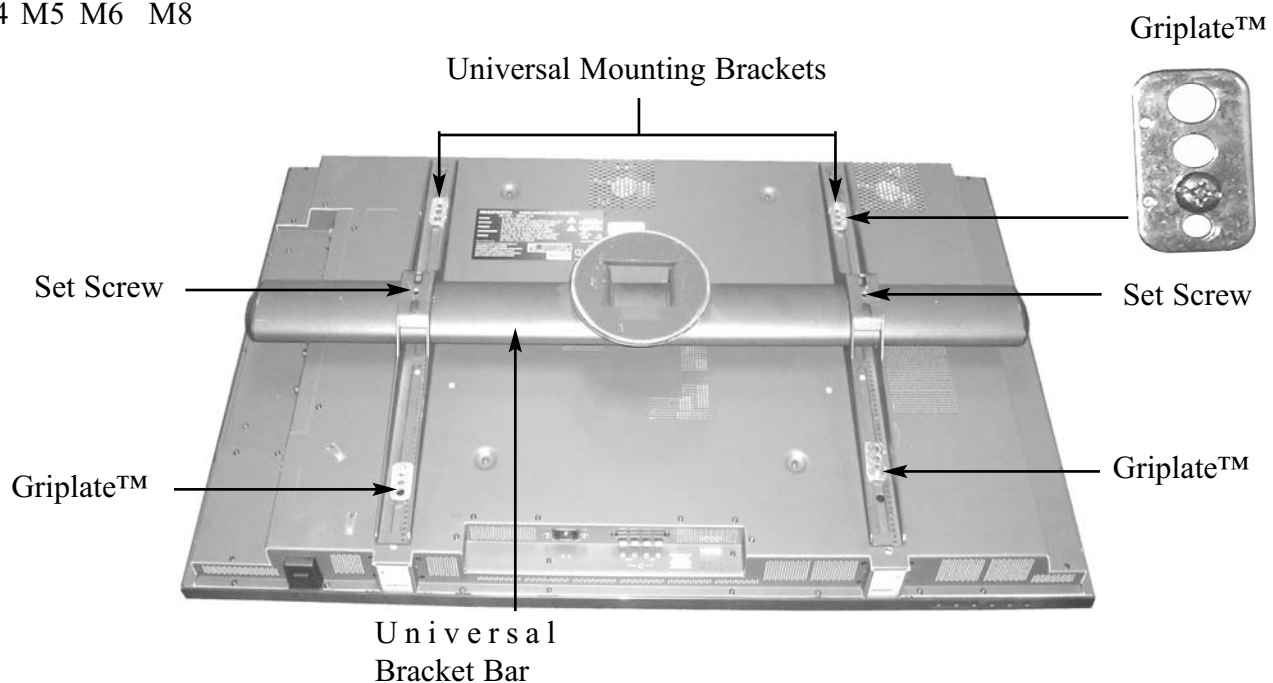
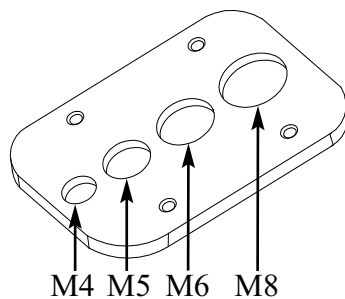

WARNING: IT WILL TAKE TWO PEOPLE TO COMPLETE THE NEXT INSTALLATION STEP.

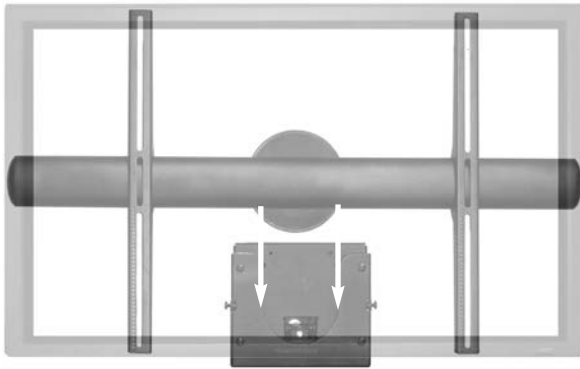

3. Lower the universal bracket bar and display into the cradle (as to the left).



Nylon Sleeve

NOTE: The circular portion of the universal bracket bar must rest inside the nylon sleeve. If seated improperly, the operation of the RTM-L will be hindered and the nylon sleeve will become damaged.

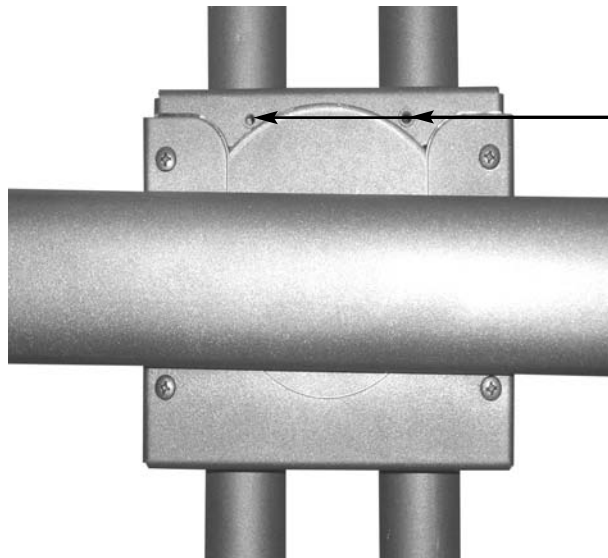

Knurl Knob Mounting Points (a knurl knob may be placed in either mounting hole)

4. Insert an M6 knurl knob into the knurl knob mounting point and tighten.

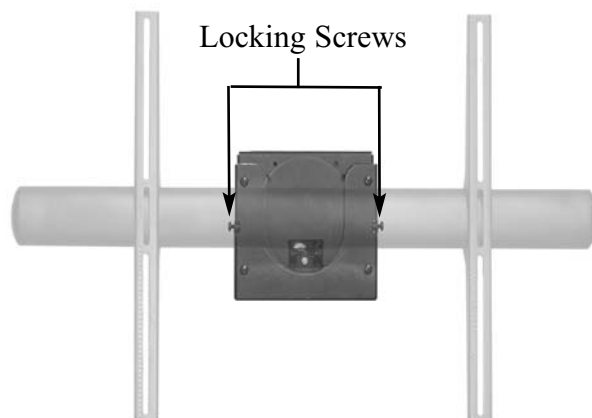

Locking Screws

5. Tighten the two (2) Phillips head screws (located on the side of the mounting block) once the final position is attained.



Display Orientation

The RTM-L will allow the user to adjust the display a full 360°.

WARNING: BEFORE ROTATING THE RTM-L, MAKE SURE THAT THE M6 KNURL KNOB IS SECURELY FASTENED TO THE RTM-L. ALSO, PLEASE MAKE SURE YOU ALLOW ENOUGH CABLE AND WIRE CLEARANCE FOR FULL ROTATION.

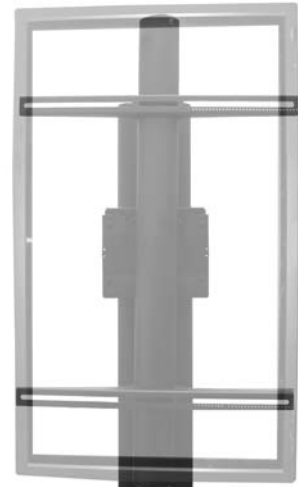
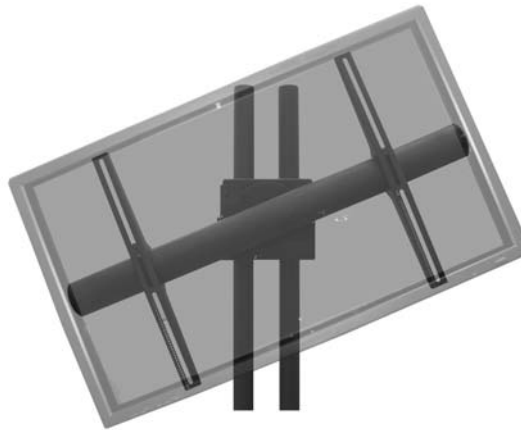
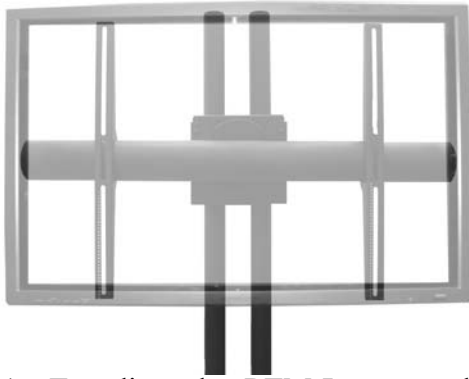

1. To adjust the RTM-L, rotate the display either clockwise or counter-clockwise.

2. Tighten the two Phillips head locking screws (see Step 5, Page 10).

Tilt Positioning



Rotate the crank handle to tilt the RTM-L:
Down - Clockwise
Up - Counter-Clockwise



The RTM-L has the ability to tilt 10° down.

The RTM-L has the ability to tilt 35° up.

1. Once the position has been locked down, use an Allen wrench to take off the crank handle.
2. Once the crank handle has been removed, re-attach the crank handle, but in the opposite direction from what it was. This is the storage position for the handle.



Optional Configurations



PSD-TS

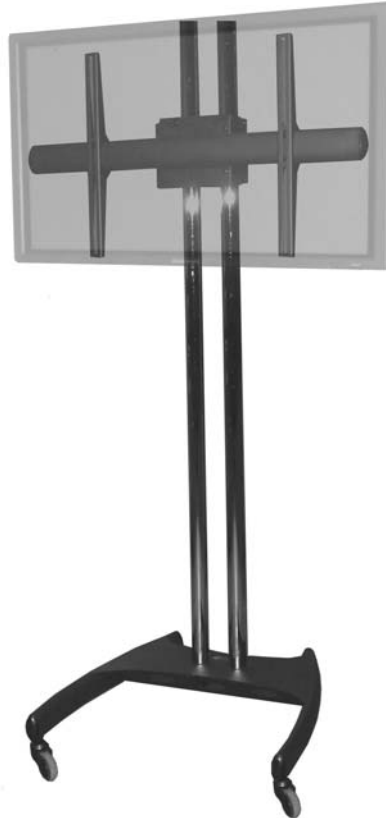

PSD-BW



PSD-EB

Technical Specifications

All measurements are in inches (mm).

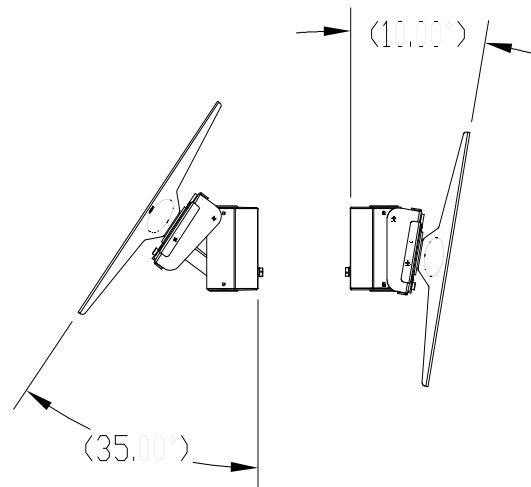
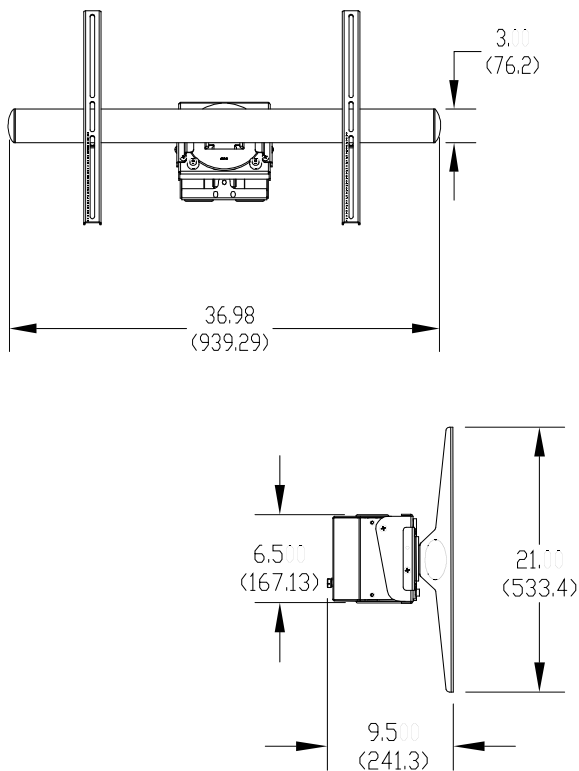



RTM-L ADDENDUM:



The RTM-L is shipped with the hand crank in the storage position. The hand crank must be removed in order for the RTM-L to be adjusted. After the adjustments have been made, return the hand crank to the storage position. If the hand crank is not returned to the storage position, it may cause damage to the unit or other equipment. Please return the hand crank to the storage position after operation.

Hand Crank
(Qty 1)



5/32" Allen Wrench
(Qty 1)



Storage Position

Loosen the M8 set screw using the 5/32" Allen wrench. Remove the hand crank.

Operating Position

Once the hand crank has been removed, turn the hand crank around so that the hand crank knob is pointing away from the unit. Place the hand crank back onto the unit and tighten the set screw with the 5/32" Allen wrench.

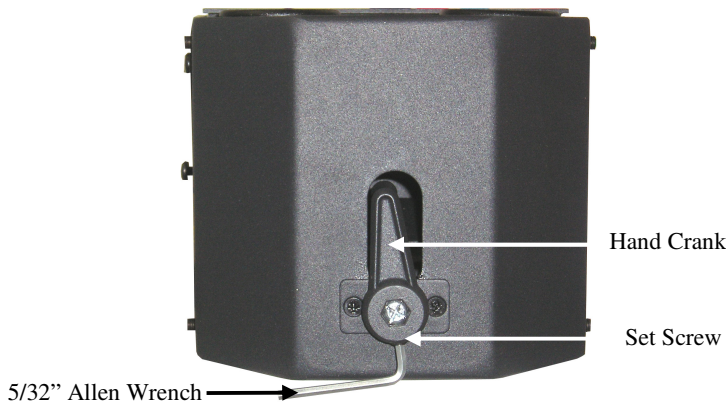

Storage Position

Slide the hand crank back onto the RTM-L and tighten the set screw using the 5/32" Allen wrench.



INSTALLATION MANUAL

PSD-SHB Black Shelf

Step 1

Open the box and remove all components.

Step 2

Slide the shelf over the poles, select the desired height and lock the height by tightening the four (4) Allen head screws using the hex key.

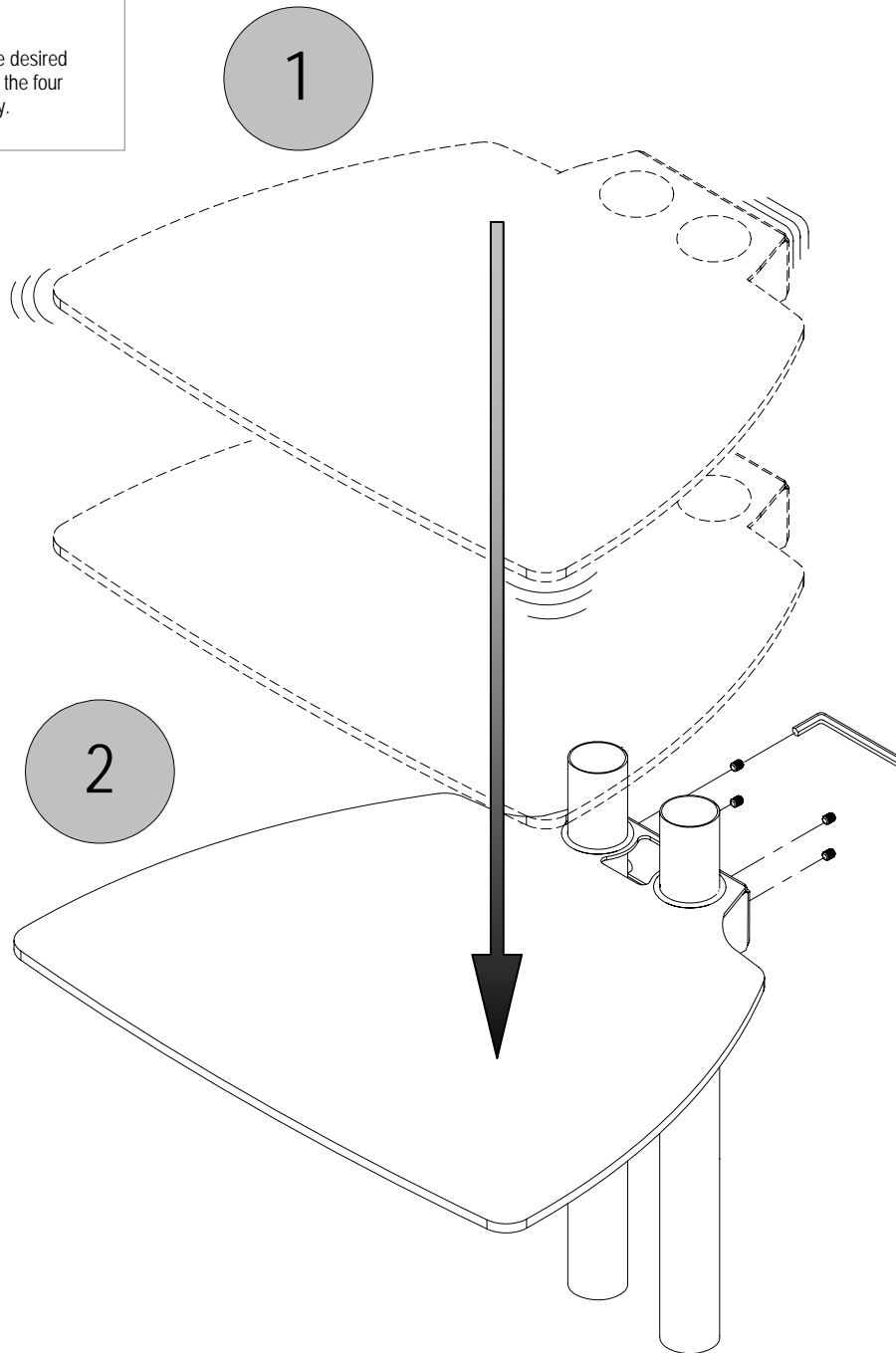

 **PREMIER
MOUNTS™**
The original holding company

Phone: 1300 666 099

www.idt.com.au